

Ideal Standard Showers Studio Collection



B O D Y & M I N D

*Ideal
Standard*



CONTENTS

Joy	4
Tribune	12
Chiara	18
Modular Framed	28
Modular Frameless	36
Connect	42
Shower Trays	48
Technical Information	52
Guarantee	62

B O D Y & M I N D

At Ideal Standard, we believe that **creativity** is the catalyst to constant evolution. As Europe's leading **contemporary** bathroom brand, we create bathrooms that integrate functional solutions with inspirational style allowing you to express your own personal flair. Ideal Standard is dedicated to enhancing the total environment of your bathroom by combining **innovation** and beauty for a unique **body and mind** experience.



The Studio collection is a refreshingly **modern** range of shower enclosures and bath screens.



New ideas and **thoughtful** features run right across the range, whilst innovative design and contemporary styling add a lighter, **fresher** feeling to showertime. And its a feeling you can depend upon again and again, as our enclosures and screens meet or exceed all relevant UK and European standards.

joy

Available in a wide range of sizes, all in silver finish, Joy's clean styling will complement any bathroom. The uncompromising engineering is reflected in the ten year guarantee for the enclosure and the two year guarantee for the IdealClean coating. Features include

- High quality robust framed enclosures
- Wide range of shapes and sizes
- Silver finish aluminium
- Pivot or space - saving Slider doors
- Installation flexibility through use of spacers
- Toughened 6mm clear safety glass with IdealClean coating





▲ Joy Corner Pivot

Make a grand entrance with the Pivot door, which opens wide to allow easy, open access to the shower.

Available in sizes: 700, 750, 800, 850 and 900.

Shown here with Trevi Outline valve and Trevi Outline shower kit.



▶ Joy Corner Entry

Slider doors glide smoothly apart to give easy access to the Corner Entry - the ideal way to provide a maximum showering area where space is limited.

Available in sizes: 800, 850 and 900.

Shown here with Trevi CTV valve and Trevi CTV shower kit.



▲ **Joy Alcove Pivot**

Crisp lines characterise the clean, modern appearance of the Alcove, shown here with the smooth, easy access Pivot door.

Available in sizes: 700, 750, 800, 850 and 900.

Shown here with Trevi Outline valve and Trevi Outline shower kit.

◀ **Joy Large Alcove Pivot**
Joy Large Corner Pivot (not shown)

If you like plenty of space to express yourself then these are the showers for you. Shown here is the Alcove, just add a side panel to create the spacious Corner option.

Available in size: 1200.

Shown here with Trevi CTV valve and Trevi CTV shower kit.



▲ Joy Large Alcove Slider

Joy Large Corner Slider (not shown)

Slip smoothly into your shower with the stylish and durable Slider door. Shown here is the Alcove, just add a side panel to create the Corner option.

Available in sizes: 1000, 1100, 1150 and 1200.

Shown here with Trevi CTV valve and Trevi CTV shower kit.



Joy Quadrant ▶

The Quadrant, featuring curved Slider doors, offers you a contemporary and distinctive option for creating a spacious showering area.

Available in sizes: 800 and 900.

Shown here with Trevi Outline valve and Trevi Outline shower kit.

tribune

Simplicity can be a virtue in today's crowded world and Tribune's sleek, simple lines offer a classic look with a refreshingly modern twist. Sturdy silver finish frames and smooth, high quality hinges add practicality and durability. Features include • High quality robust framed enclosures with elegant frameless pivot doors • Silver finish aluminium • Toughened 6mm clear safety glass





▲ **Tribune Corner Pivot with Infill Panel**

This spacious Corner combines strength and durability with classic, uncluttered style.

Available in sizes: 900 and 1200.

Shown here with Trevi TT Oposta shower valve and Trevi Moonshadow SC shower kit.

◀ **Tribune Corner Pivot**

The Tribune Corner features a frameless pivot door which opens outwards for easy access without intruding too far into the room.

Available in sizes: 750 / 800.

Shown here with Trevi TT Rivage shower valve and Trevi Moonshadow BC shower kit.

For more information on Ideal-Standard visit www.barbourproductsearch.info

◀ **Tribune Alcove Pivot with Infill Panel**

The extra space offered by this larger enclosure perfectly complements Tribune's light, modern feel.

Available in sizes: 900 and 1200.

Shown here with Trevi TT Oposta shower valve and Trevi Moonshadow SC shower kit.



Tribune Alcove Pivot

The Tribune Alcove brings a simple, elegant style to smaller alcove spaces.

Available in sizes: 750 / 800.

Shown here with Trevi TT Rivage shower valve and Trevi Moonshadow SC shower kit.



Tribune Pentagon

The Pentagon's space saving design creates enough space to shower in comfort, whilst fitting snugly into the corner of even the smallest bathroom.

Available in size: 900.

Shown here with Trevi TT Ascari shower valve and Trevi Moonshadow BC shower kit.

chiara

Its always nice to have options. Chiara is a flexible range which is designed to fit any space between two walls ranging from 690mm to 1410mm in length. Features include

- Choice of Pivot, Bi-fold or Slider doors
- Total flexibility to suit installation
- Additional adjustment for out of true walls
- Available in Clear or Modesty glass
- A choice of frame finishes in polished silver or white
- Toughened 3mm clear safety glass





◀ Chiara Corner Pivot

The Chiara corner enclosure emphasises what the range is all about. Its clean, clear lines combine with total flexibility, making it easy to install in almost any bathroom.

Available in sizes: 760, 800 and 900.

Shown here with Trevi TT Rivage shower valve and Trevi Moonshadow SC shower kit.

▲ Chiara Corner Bi-fold

The popular corner enclosure combines with a smooth operating bi-fold door to give easy shower access, even where space is limited.

Available in sizes: 760, 800 and 900.

Shown here with Trevi TT Ascari shower valve and Trevi Moonshadow SC shower kit.



If you prefer a modesty glass enclosure, all Chiara enclosures are available with a distinctive modesty pattern glass.



Chiara Corner Entry Slider

Make the most of your space with the Chiara Corner Entry enclosure. The two doors slide smoothly to meet at the corner, creating an effective space-saving seal.

Available in sizes: 760 and 800.

Shown here with Trevi TT Ascari shower valve and Trevi Moonshadow FRC shower kit.

Chiara Alcove Pivot

Always a popular configuration, the Chiara Alcove Pivot offers a spacious and practical showering area with hinged doors that swing open to give easy access to the shower.

Available in sizes: 700, 760, 800 and 900.

Shown here with Trevi TT Oposta shower valve and Trevi Moonshadow SC shower kit.



Chiara Alcove Bi-fold

The flexibility of the Chiara range is beautifully illustrated by the Alcove Bi-fold, offering stylish showering in even the smallest of bathrooms.

Available in sizes: 760, 800 and 900.

Shown here with Trevi TT Ascari shower valve and Trevi Moonshadow BC shower kit.

For more information on Ideal-Standard visit www.barbourproductsearch.info

◀ Chiara Large Alcove Pivot

Chiara Large Corner Pivot (not shown)

A pivot door combines with a glass front panel giving a light, luxurious feel to this large enclosure. Shown here is the Alcove, just add a side panel to create the spacious Corner option.

Available in size: 1200.

Shown here with Trevi TT Central Therm shower valve and Trevi Moonshadow ILV shower kit.



Chiara Large Alcove Bi-fold

Chiara Large Corner Bi-fold (not shown)

The large 1200mm alcove brings extra showering room into alcove areas, and the space efficient bi-fold door means its generous showering area can be fitted into a surprisingly compact space. To create a Corner bi-fold enclosure, just add a side panel.

Available in size: 1200.

Shown here with Trevi TT Oposta shower valve and Trevi Moonshadow SC shower kit.

Chiara Large Alcove Slider

Chiara Large Corner Slider (not shown)

Always a pleasure to use, the sliding door glides smoothly open to give easy access to the large 1200mm showering area. Shown here is the Alcove, just add a side panel to create the spacious Corner option.

Available in size: 1200.

Shown here with Trevi TT Oposta shower valve and Trevi Moonshadow FRC shower kit.

For more information on Ideal-Standard visit www.barbourproductsearch.info

◀ Chiara Quadrant

The Chiara Quadrant, the shape of a quarter circle, is an enclosure that provides a generous showering space in the corner of a room. It is fitted with smooth sliding, curved glass doors, and is available in clear glass with a white frame that complements a contemporary bathroom style.

Available in size: 900.

Shown here with Trevi TT Ascari shower valve and Trevi Moonshadow BC shower kit.



Chiara Pentagon Pivot

A corner shower enclosure that's cleverly designed to provide plenty of showering space inside, without taking up too much room outside.

Available in size: 900.

Shown here with Trevi TT Oposta shower valve and Trevi Moonshadow BC shower kit.

Chiara Pentagon Bi-fold

Two space saving solutions in one. The clever design of the Pentagon combines with inward opening bi-fold doors for a truly practical enclosure that can be fitted into the smallest of spaces.

Available in size: 900.

Shown here with Trevi TT Ascari shower valve and Trevi Moonshadow BC shower kit.

modular framed

Modular is a brilliantly designed shower system, specifically designed to be leak free*, even in new house build installations. Modular is available in two distinctive formats. Choose between the sleek, angular lines of Modular framed (pages 32-35) and the lighter, elegant appeal of Modular frameless (pages 38-41). Features include

- Flexible installation - Modular can be installed during the first or second fix phase of house construction, with little or no disturbance
- Patented sealing solution - a silicone-free sealing system that ensures a seal even after any floor settlement
- Integrated framed or semi-frameless enclosure system
- Toughened 6mm clear safety glass

* Provided installation is carried out according to manufacturer's installation instructions





Trevi Outline high pressure:



Trevi Outline low pressure:

Full force



Intermediate



Concentrated needle



Trevi CTV high pressure:

Full force



Champagne



Pulse massage



Trevi CTV low pressure:

Full force



Intermediate



Concentrated needle



modular

How Modular Works

Modular has been designed to be leak free when properly installed, even in new build housing. The patented seal system enables the cubicle to be leak free even during house settlement. Easy to install and easy to maintain, Modular is truly innovative in its design.

- 1 Modular can be installed before or after the bathroom tiling has been done. The pre-tiling does not need to be precisely calculated as Modular can be fitted over existing tiled or part-tiled walls.
- 2 Modular's shower tray features adjustable legs making it easy to obtain a level tray - an important requirement for a leak free shower.

- 3 Pre-plumbed column has push-fit fittings for easy connection and is fastened to the wall using adjustable brackets that fit onto bosses attached to the tray ensuring an accurate fit, even with out of true walls.
- 4 Aluminium framed acrylic capped ABS walls slide onto the tray and column and are then fitted to the wall using adjustable sliding brackets.
- 5 Aluminum compensating profiles add the finishing touches to the cubicle.
- 6 The enclosure is added at the final stage of installation which includes cover caps and strips that finish the sealing of the unit to ensure a complete leak free showering experience.

Shower Valves and Kits

Modular is available with a choice of two high quality thermostatic valves and shower kits. They conceal a highly engineered system that delivers a constant water temperature, regardless of pressure fluctuations elsewhere in the house. Both feature a safety stop at 43°C and automatic shutdown should the cold water supply fail.

Trevi Outline (above left) has the look of a design classic. Its twin cylindrical handles, one for water flow, one for temperature, make fine adjustments easy, even with eyes closed.

Trevi CTV (above right) is a stylish concentric thermostatic shower valve offering precise temperature control that remains constant when the water pressure falls.

Both shower kits feature an adjustable shower rail with integrated soap dish.

Spray Patterns

Both shower valves are available with either a low pressure or high pressure chromium plated shower kit, offering a wide range of spray options.

Shower Trays

Modular is supplied with Strada Upstand Riser trays - a stylish range of ABS capped shower trays. These trays are extremely strong and durable, and feature an elegant tray pattern design.

Strada Upstand Riser shower trays feature an innovative method of using fully adjustable feet and fixing panels to ensure a better fit between panel and tray, enabling easier access to plumbing.



Modular Framed Corner

This classic configuration, complete with a smooth action pivot door offers a spacious and practical showering area.

*Available in sizes: 800 and 900.
Shown here with Trevi Outline valve and Trevi Outline shower kit.*



Modular Framed Corner Entry

The Modular Framed Corner Entry features twin slider doors that glide smoothly apart to give easy access where space is limited.

*Available in sizes: 800 and 900.
Shown here with Trevi Outline valve and Trevi Outline shower kit.*



Modular Framed 1200 Corner

The 1200 Corner's luxurious showering area complemented by a space efficient slider door, truly maximises space in the bathroom.

*Available in size: 1200.
Shown here with Trevi Outline valve and Trevi Outline shower kit.*

For more information on Ideal-Standard visit www.barbourproductsearch.info

◀ Modular Framed Large Alcove

The Modular Framed Large Alcove, featuring a space efficient slider door, brings more space, more light and more enjoyment to showertime.

Available in size: 1200.

Shown here with Trevi CTV valve and Trevi CTV shower kit.



Modular Framed Alcove

The Modular Framed Alcove brings dependable, leak free showering into those awkward to use spaces, whilst clean lines and crisp styling add a touch of modern flair.

Available in sizes: 800 and 900.

Shown here with Trevi CTV valve and Trevi CTV shower kit.



Modular Framed Quadrant

Flowing lines and curved glass give the Modular Framed Quadrant a special appeal for buyers looking for something distinctive and contemporary.

Available in sizes: 800 and 900.

Shown here with Trevi Outline valve and Trevi Outline shower kit.

modular framed

modular frameless

Modular's modern design, patented sealing solution and easy maintenance make it the ideal choice for anybody looking for supreme performance and reliability from their shower. Modular is available in two distinctive formats. Choose between the sleek, angular lines of Modular framed (pages 32-35) and the lighter, elegant appeal of Modular frameless (pages 38-41). Features include

- Flexible installation - Modular can be installed during the first or second fix phase of house construction, with little or no disturbance
- Patented sealing solution - a silicone-free sealing system that ensures a seal even after any floor settlement
- Integrated framed or semi-frameless enclosure system
- Toughened 6mm clear safety glass





Modular Frameless Corner

Always a popular configuration, the Modular Frameless Corner offers a spacious and practical showering area with a hinged door that swings open to give easy access to the shower.

Available in sizes: 800 and 900.

Shown here with Trevi CTV valve and Trevi CTV shower kit.



Modular Frameless Corner Entry

Modular Frameless Corner Entry features two large opening doors giving easy access and a light, airy feel to the shower.

Available in sizes: 800 and 900.

Shown here with Trevi CTV valve and Trevi CTV shower kit.



Modular Frameless 1200 Corner

Acres of space and a frameless enclosure gives the 1200 Corner a touch of luxury that discerning buyers will appreciate.

Available in size: 1200.

Shown here with Trevi Outline valve and Trevi Outline shower kit.



Modular Frameless Alcove

Perfect for the smaller bathroom. It's clean lines and airy feel adds a touch of modern style.

Available in sizes: 800 and 900.

Shown here with Trevi Outline valve and Trevi Outline shower kit.



Modular Frameless Large Alcove

Maximising the showering area, this Large Alcove features hinged doors to allow easy access.

Available in size: 1200.

Shown here with Trevi Outline valve and Trevi Outline shower kit.



Modular Frameless Quadrant

Twin frameless hinged doors and a series of sensuous curves give this enclosure a strikingly modern appearance.

Available in sizes: 800 and 900.

Shown here with Trevi CTV valve and Trevi CTV shower kit.



Modular Frameless Pentagon

The innovative curved glass doors of the Pentagon enclosure demonstrate that you can save on space without compromising on style.

Available in size: 900.

Shown here with Trevi CTV valve and Trevi CTV shower kit.

connect

With Connect you can have the best of both worlds - luxurious baths and invigorating showers, all within the same environment. The design conceals a host of innovative features that make owning and using a Connect screen simplicity itself. Or, if you prefer a shower curtain, the Connect Showerguard screen is perfect as an additional barrier against leakages. Features include

- Options to suit a wide variety of baths
- Toughened 5mm clear safety glass
- Silver finish aluminium
- Rising and falling hinges for ease of operation
- Adjustment for out of true walls
- Ideal Standard deflector seal





Connect 750

The Connect 750 has been designed for more compact baths. The screen offers extra protection with a larger than average 1500mm height.

Shown here with Trevi CTV Exposed shower valve and Trevi CTV shower kit.

Connect 900

The Connect 900 is recommended for standard and larger size baths. With a width of 900mm and a height of 1500mm this screen provides a greater area of protection.

Shown here with Trevi Outline shower valve and Trevi Outline fixed overhead.

Customise Your Connect

As well as a choice of sizes, Connect offers you further options so you can choose the screen that's just right for you.

All Connect screens include an aluminium deflector bar which can be used to give further leak protection. This bar is particularly useful on shaped baths where the straight line of the screen along the inner curves of the bath can result in awkward gaps. Just install this deflector bar to enjoy an invigorating shower with peace of mind.

The Connect Chrome upgrade kit is an optional extra, offering an additional touch of style and practicality in the form of a distinctive chrome plated handle and aluminium seal. The stylish handle keeps those fingerprints off the glass and provides a better grip when operating. The seal incorporates Ideal Standard's unique water deflector system - a breakthrough in preventing water leakage.

Above top left - Connect 750 shower screen with aluminium deflector bar (ideal for curved and sculpted baths).

Above left - Connect 750 shower screen with aluminium sealer strip.

Above - Connect 750 with Chrome Upgrade kit and Trevi CTV exposed shower valve and Trevi CTV shower kit.



Connect Shower Guard Corner

If you prefer to shower with a curtain, then the Connect Shower Guard offers a neat and effective solution. The small Shower Guard screen combines with your curtain, forming an effective barrier to stop water from escaping.

Curtain and hooks not supplied.

Available in size: 255 x 1570mm.
Rail dimension: 1100 x 650mm.

Connect Shower Guard Alcove

For baths fitted into alcoves, this arrangement allows the curtain to run along the full length of the bath, offering an even larger showering space.

Curtain and hooks not supplied.

Available in size: 255 x 1570mm.
Rail dimension: 1800mm.

Connect Shower Guard without rail

The Connect Shower Guard is available without the corner or alcove curtain rail.

Connect 4 Panel (not shown) Connect 5 Panel

The Connect 4 and 5 Panel screens offer a versatile and compact alternative to a shower curtain, taking up very little space when folded.

Connect 4 Panel size: 890 x 1340mm.
Connect 5 Panel size: 1100 x 1340mm.
Connect 5 Panel shown here with Trevi TT Oposta shower valve and Trevi Moonshadow BC shower kit.

Connect Rialto

The Rialto bath screen is made from 8mm toughened safety glass. It can be mounted to close in either direction, pivoting effortlessly into place to form a water-tight seal. It is available in clear glass with chrome plated hinges.

Available in size: 765 x 1340mm.
Connect Rialto shown here with Trevi TT Ascari shower valve and Trevi Moonshadow BC shower kit.

shower trays

Ideal Standard shower trays are available in a choice of materials and with many options of shape and size. There are square trays ranging from 700mm to 900mm, rectangular trays in a variety of lengths and widths plus a range of trays designed for corner installation. Whichever you choose, they all carry a lifetime guarantee for complete peace of mind.



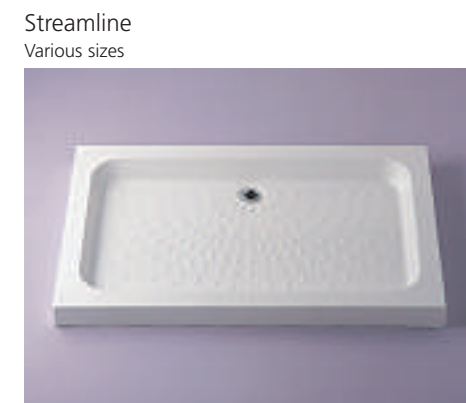

Installation

Flat Top tray installation - the shower tray is placed against a finished wall, with tiling to the top of the tray.

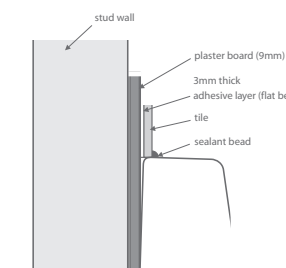

Upstand tray installation - the shower tray is placed against a finished wall, with plasterboard on top of the Upstand. The tray is then tiled into the wall by tiling over the Upstand onto the tray.

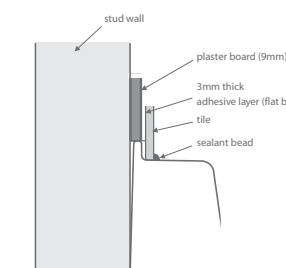

Strada

Strada is an elegant range of durable ABS capped shower trays, available in a selection of shapes and sizes. All trays feature a stylish tray pattern, scratch resistant finish and lifetime guarantee.

Strada trays are available as either Flat Tops or Upstands. Strada Upstand trays feature a continuous integral upstand around the edge that is tiled into the wall to minimise water leaks.

Both Upstand and Flat Top trays will minimise leakage when properly installed.

Features include:

- 7 different sizes available (including Upstand)
- Available in White and Pergamon
- High impact resistance
- High quality gloss finish
- Scratch resistant
- Lifetime guarantee
- Strada Flat Top tray height 95mm
- Strada Upstand tray height 110mm

Strada Risers

Strada Riser shower trays come with attractive front and side panels which are installed using an innovative method of fully adjustable feet and fixing panels to ensure a better fit between panel and tray.

Strada Riser shower trays are available with or without upstands.

- Strada Riser tray height 225mm
- Strada Upstand Riser tray height 240mm

Streamline

Streamline resin stone trays provide a really rigid base to stand on and are only 95mm in height. Resin stone is a solid material that has proved to be extremely sturdy, durable and reliable.

All Streamline trays are available as flat tops. A selection of the square and rectangular trays are available with 2 or 3 upstands and/or as riser trays.

Upstands run around the edge of the tray and create a water tight seal between the shower tray and each wall, allowing for any subsequent movement in the floor.

Kielder

The Kielder range of shower trays provide easy access to the shower enclosure. Kielder trays are only 70mm high, which makes stepping into the tray easier.

TECHNICAL INFORMATION

JOY

Joy Corner Pivot

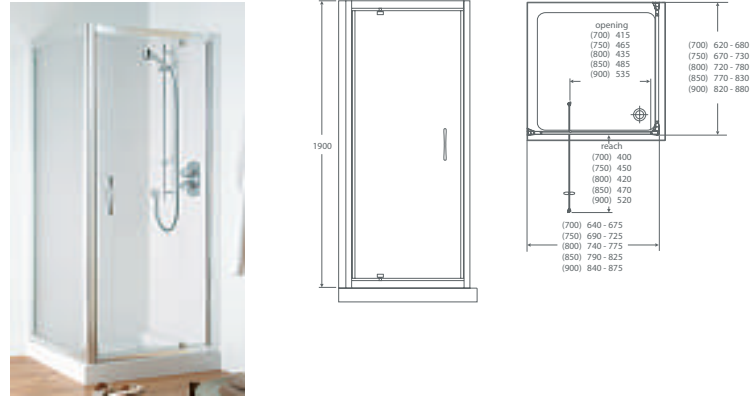

Joy Alcove Pivot



Joy Corner Entry



Joy Large Alcove Slider

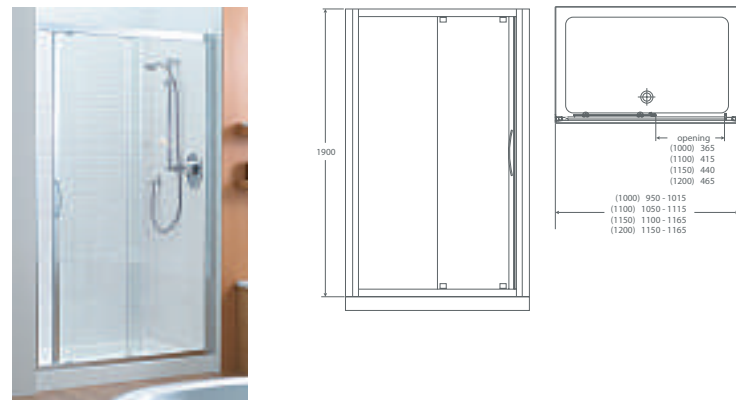

Joy Large Alcove Pivot

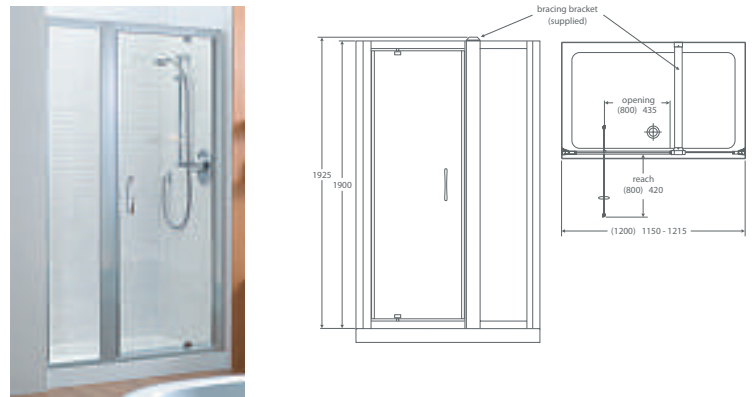

Joy Large Corner Slider

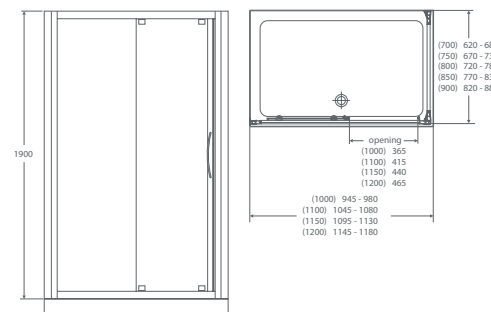

Joy Large Corner Pivot

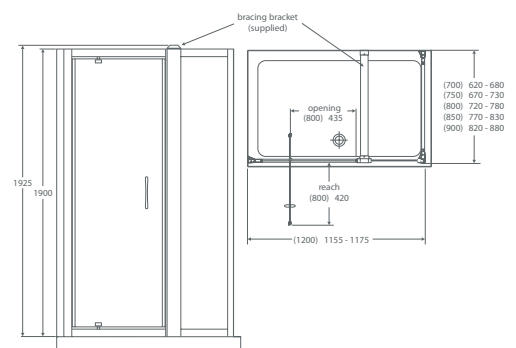

Joy Quadrant



TECHNICAL INFORMATION

Installation flexibility

Intermediate sized enclosures

To assist with installation problems, the Joy range offers Intermediate sized enclosures. This is for situations where the original size of enclosure cannot fit within the space but the next size down is too small.

For example, with a 900 Corner enclosure, if the 900mm tray has been installed but tiling has greatly reduced the enclosure area, then an 850 Corner enclosure can be used instead.

Spacers

Additional versatility is gained through the use of spacers. This allows the same enclosure to be installed on either a Flat Top or an Upstand tray by creating an extra 13mm adjustment per spacer.

Each profile comes with a spacer to help ease the installation process.

Tribune 1200 Corner

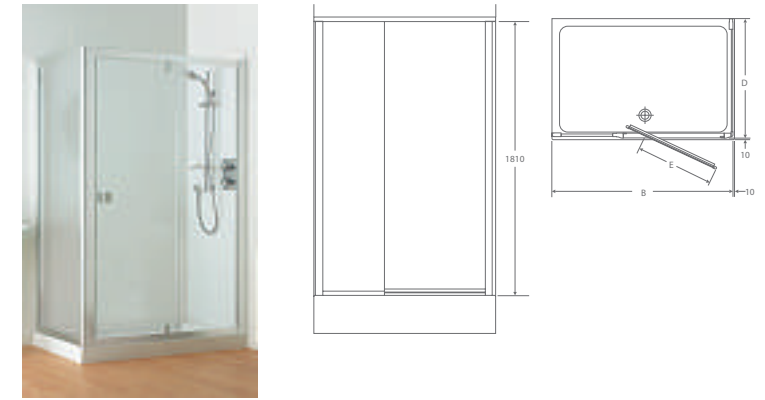

Tribune Large Alcove



Tribune Alcove



Tribune Pentagon



900 Alcove unit shown

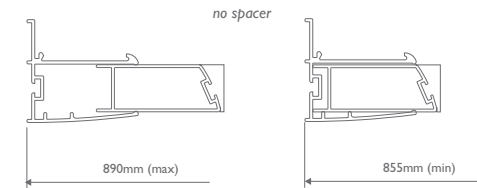
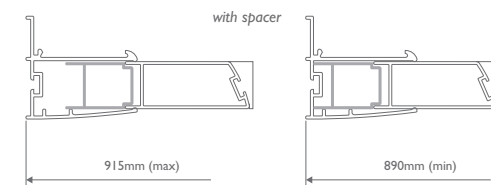

TRIBUNE

Tribune Corner



	A max/min	B max/min	B max/min	E
750/800 Door	805/705	805/705		500
750 Side panel			757/731	
800 Side panel			797/771	
900 Door	906/840	906/840		595
900 Side panel			897/871	
1200	1206/1140	1206/1140	757/731	500
Pentagon				500

Please note that the Tribune 900 door consists of a pivot door and infill panel as shown in the 1200 Corner and 1200 Alcove drawings.

TECHNICAL INFORMATION

CHIARA

Chiara Corner Pivot

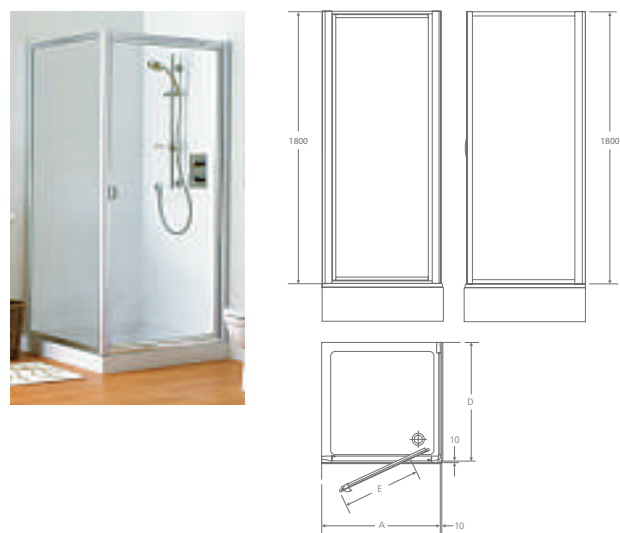

Chiara Corner Bi-fold



Chiara Corner Entry Slider

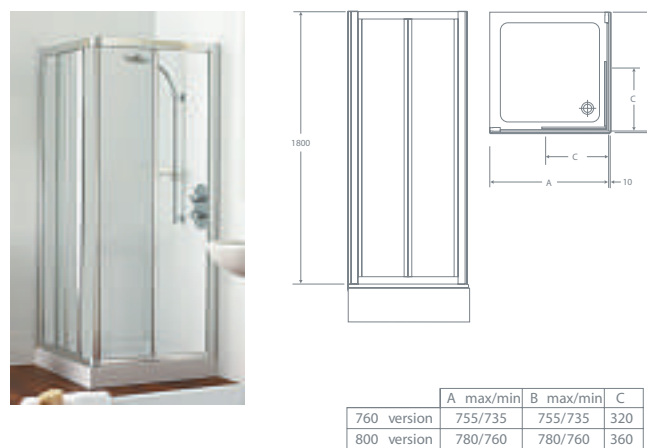

Chiara Alcove Pivot



Chiara Alcove Bi-fold



Chiara Large Alcove Pivot



Chiara Large Corner Pivot

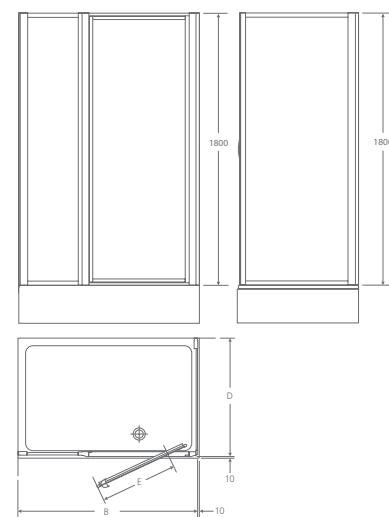

TECHNICAL INFORMATION

Chiara Large Alcove Bi-fold



Chiara Large Corner Bi-fold

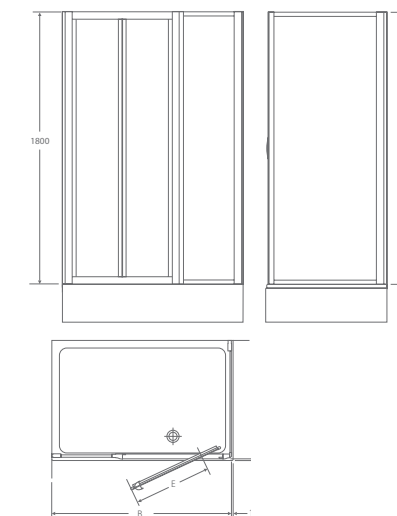

Chiara Large Alcove Slider

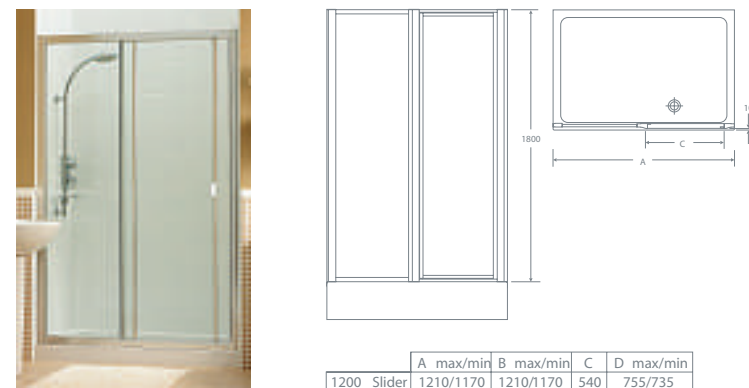

Chiara Large Corner Slider

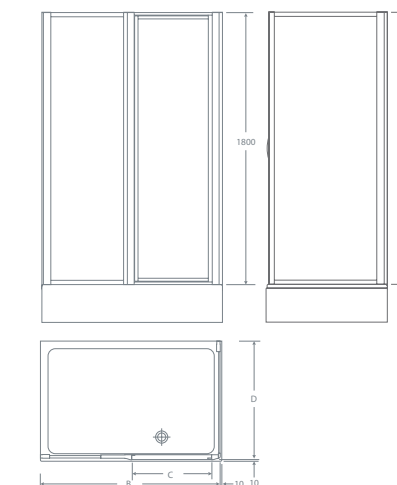

Chiara Quadrant



Chiara Pentagon Pivot



Chiara Pentagon Bi-fold



Chiara Dimensions

Pivot Range

	A min/max	B min/max	D min/max	E
700 version	690/720	685/705	680/700	445
760 version	730/760	725/745	720/740	500
800 version	780/810	775/795	770/790	530
900 version	880/910	875/895	870/890	595
Front 45cm panel	1180/1210	1180/1210	730/750	500
Pentagon			354/374	445

Bi-fold Range

	A min/max	B min/max	D min/max	E
760 version	730/760	725/745	720/740	430
800 version	780/810	775/795	770/790	475
900 version	880/910	875/895	870/890	575
Front 45cm panel	1180/1210	1180/1210	730/750	430
Pentagon			354/374	395

TECHNICAL INFORMATION

MODULAR FRAMED

Modular Framed Corner

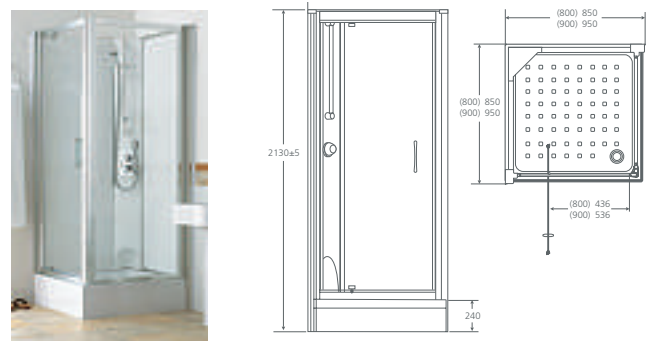

Modular Framed Corner Entry

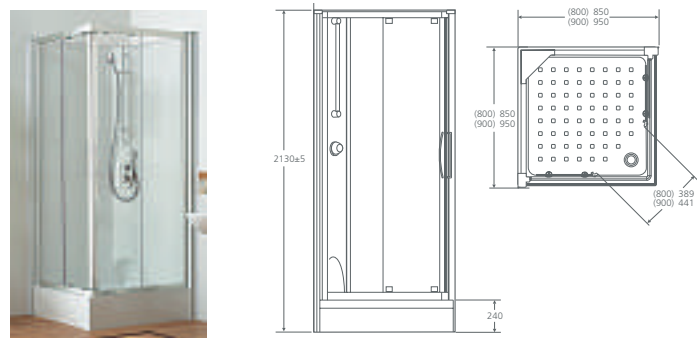

Modular Framed 1200 Corner

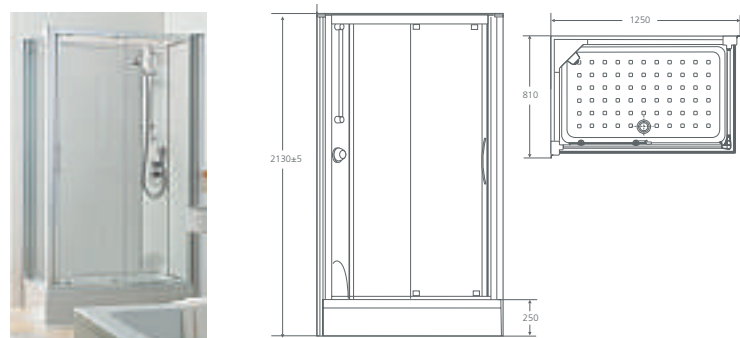

Modular Framed Large Alcove

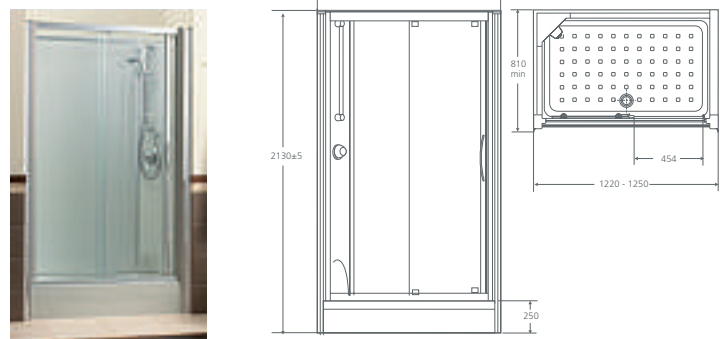

Modular Framed Alcove



Modular Framed Quadrant

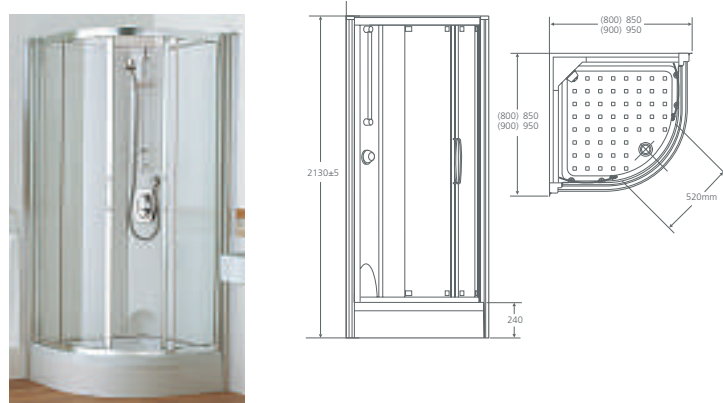

MODULAR FRAMELESS

Modular Frameless Corner

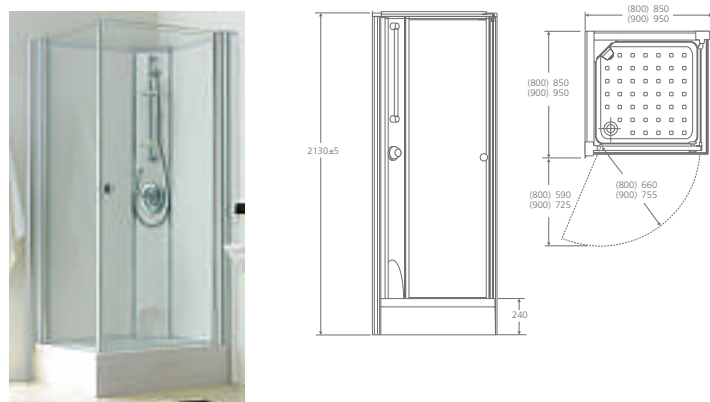

TECHNICAL INFORMATION

Modular Frameless Corner Entry



Modular Frameless 1200 Corner



Modular Frameless Alcove

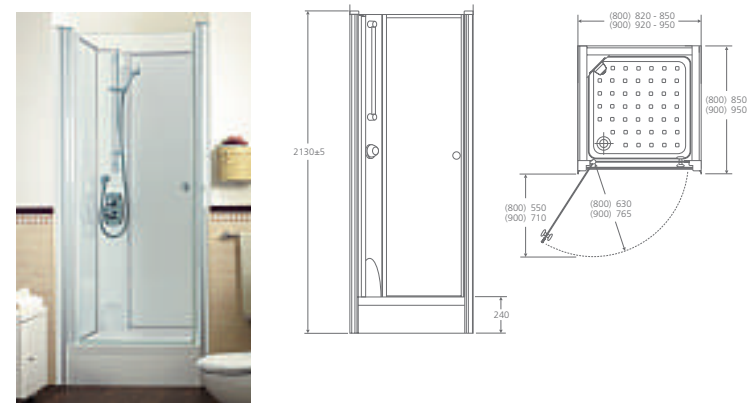

Modular Frameless Large Alcove

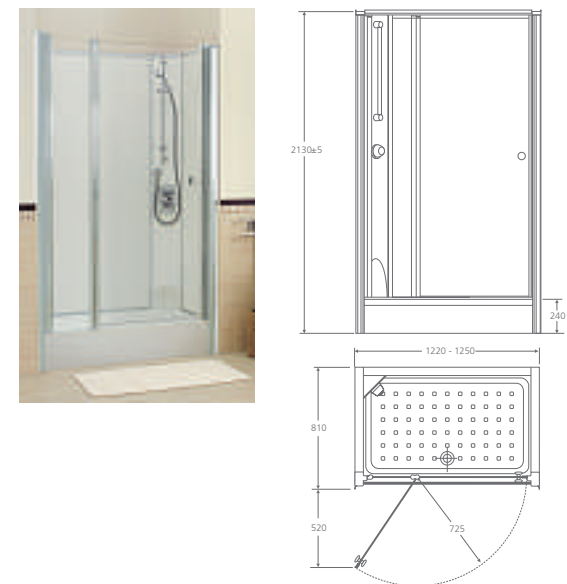

Modular Frameless Quadrant

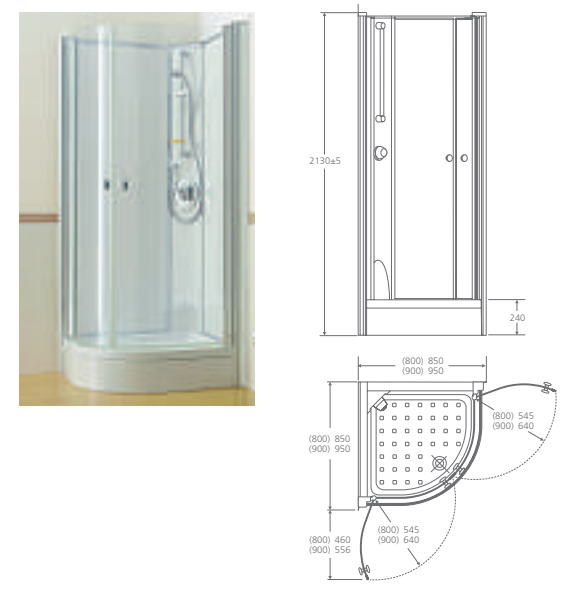

Modular Frameless Pentagon



TECHNICAL INFORMATION

CONNECT

Connect 750

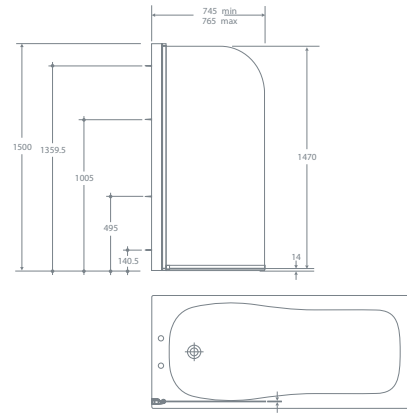
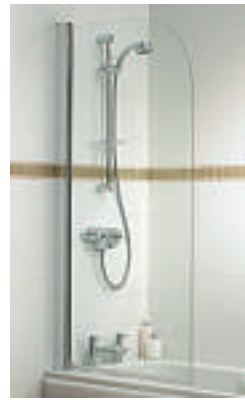

Connect Shower Guard Alcove

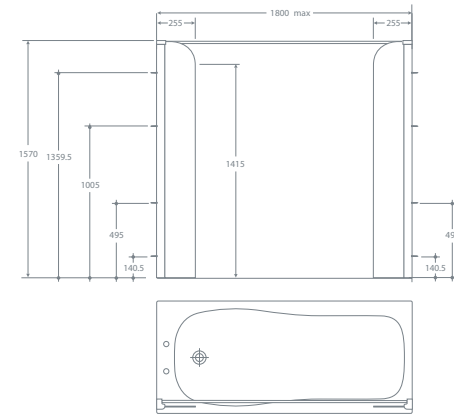

Connect 900

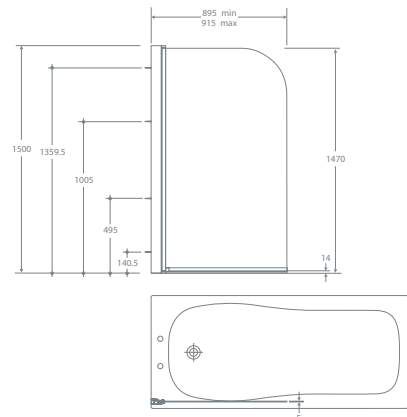

Connect 4 and 5 Panel

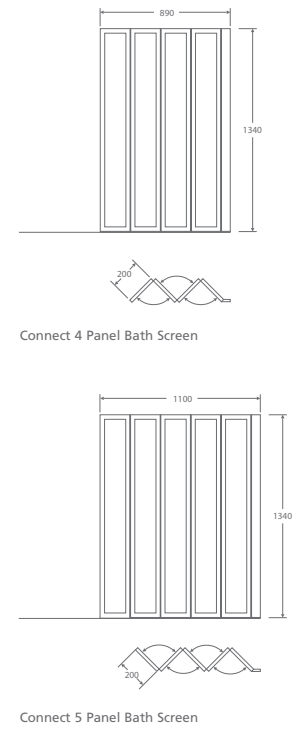

Connect Shower Guard Corner

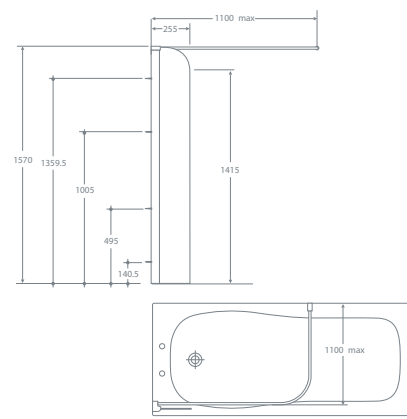

Connect Shower Guard Corner

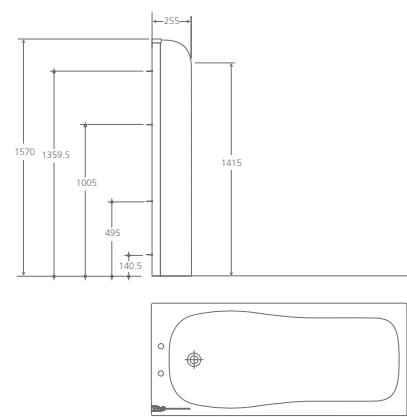

Connect Shower Guard without rail

Connect Rialto

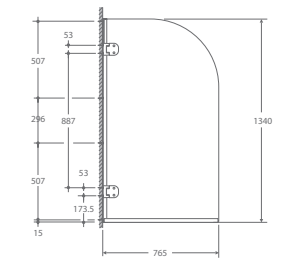

TECHNICAL INFORMATION

SHOWER TRAYS

Strada

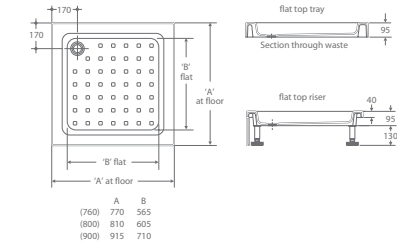

Flat Top tray

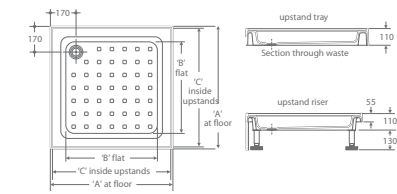

Upstand tray

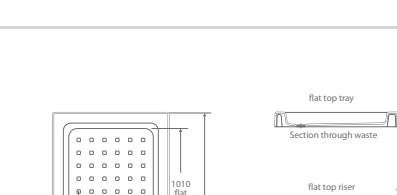

Strada 1200

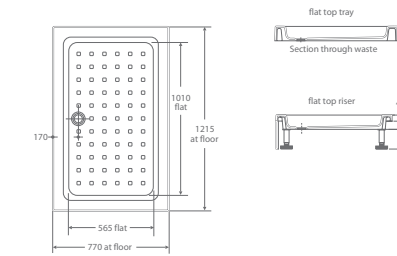

Flat Top tray

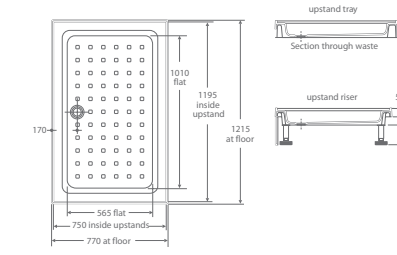

Upstand tray

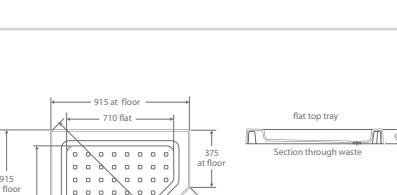

Strada Pentagon

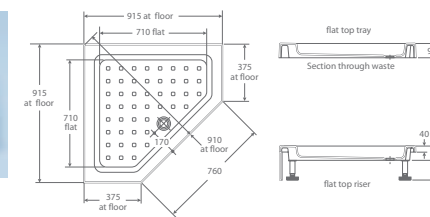

Flat Top tray

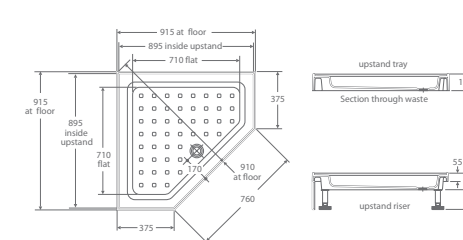

Upstand tray



Strada Quadrant

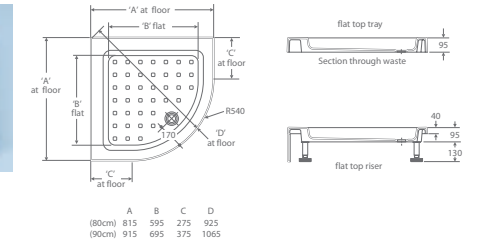

Flat Top tray

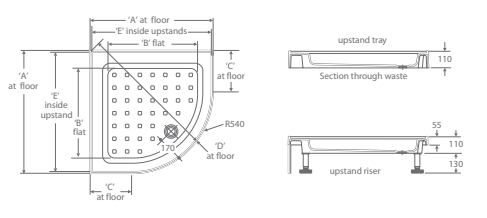

Upstand tray



TECHNICAL INFORMATION

SHOWER TRAYS

Streamline Square

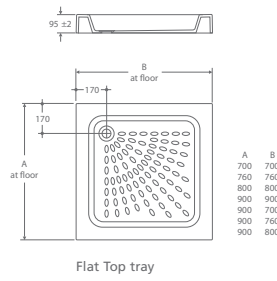

Flat Top tray

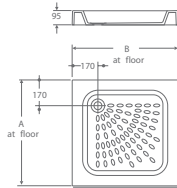

2 Upstand tray

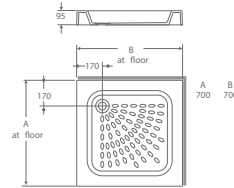

2 Upstand tray

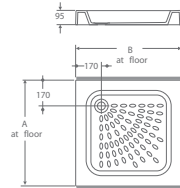

3 Upstand tray

Streamline 1200

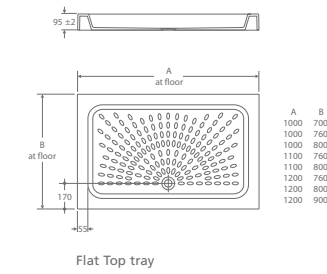

Flat Top tray

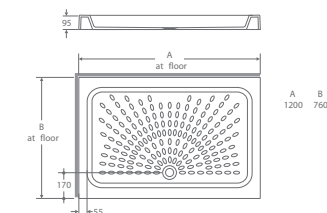

2 Upstand tray

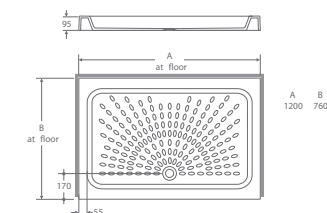

3 Upstand tray

Streamline Pentagon

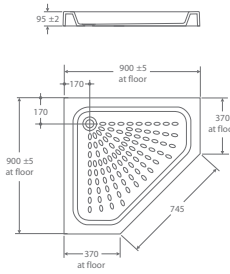

Flat Top tray

Streamline Quadrant

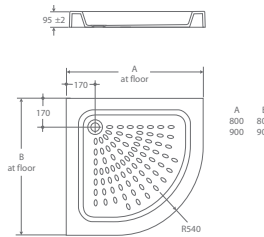

Flat Top tray

Streamline Riser Square

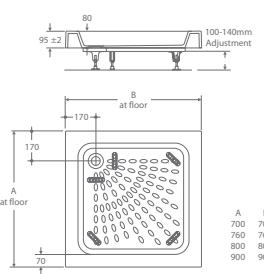

Flat Top tray

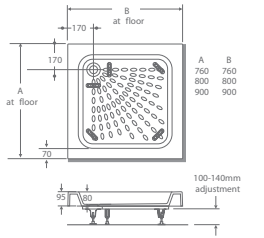

2 Upstand tray

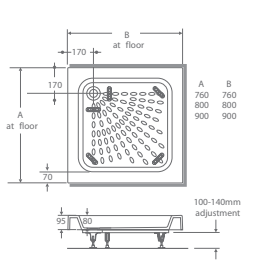

3 Upstand tray

TECHNICAL INFORMATION

Streamline Riser 1200

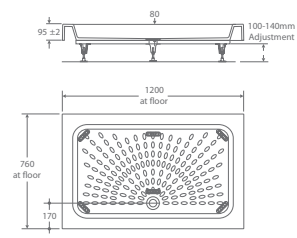

Flat Top tray

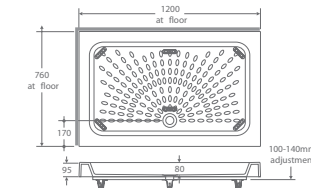

2 Upstand tray

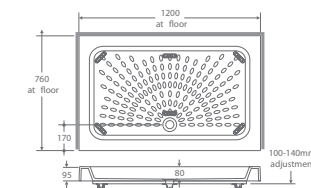

3 Upstand tray

Streamline - Upstand Trays Installation

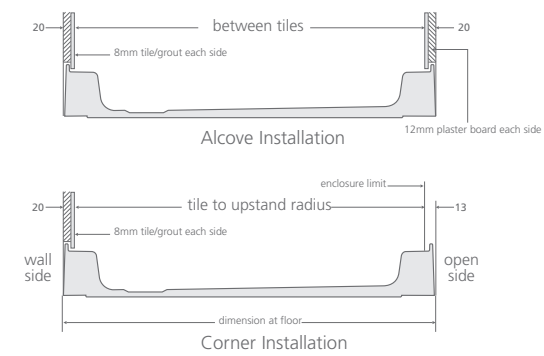

Kielder Square

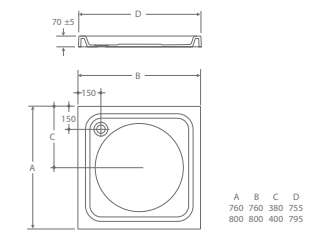

Kielder 1200

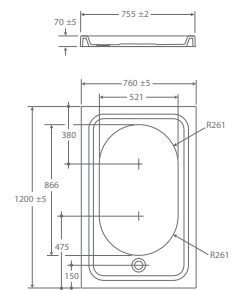

Kielder Quadrant

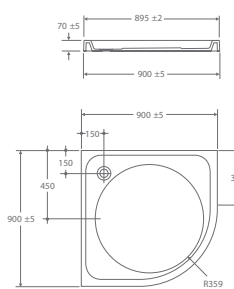

Kielder Quadrant 900

Quadrant Acrylic

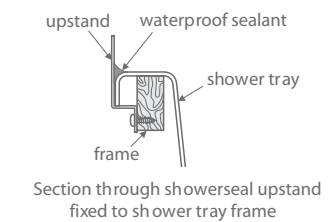
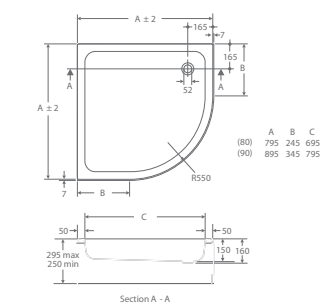

Section through shower tray upstand fixed to shower tray frame

Guarantee and Advice

Our confidence in the quality and reliability of Ideal Standard products enables us to offer long guarantees for complete peace of mind. Ideal Standard shower enclosures are guaranteed for ten years and Ideal Standard shower trays for a lifetime. Our guarantee covers all products that have been used in the manner they were intended, and does not apply to any products that have been misused or abused in any way. If any product part is found to be faulty, simply return it immediately via your chain of supply with proof of purchase (retailer receipt or installer invoice) and they will contact us, and we will organise a replacement within 48 hours. This guarantee does not affect your statutory rights. If you need installation advice, a qualified plumber will be happy to help you. We recommend you choose one who is a member of the professional bodies: the Association of Plumbing & Heating Contractors, the Institute of Plumbing and Heat Engineering or the Scottish & Northern Ireland Plumbing Employers Federation.

Freephone 0870 1296085

Bathroom designs

Page 6 & 7

Joy Corner Pivot

Shower area tiles - 310 x 420mm Sintesis matt white tiles by Ceramique Internationale.

Wall to rear of washbasin - Oak effect laminate, ref: 2510 by Formica.

Floor - 'Kudos Wood' wood effect vinyl strip flooring ref: 1902 (oak) by Polyflor.

Joy Corner Entry

Shower area tiles - 310 x 420mm Sintesis matt white tiles by Ceramique Internationale.

Floor - 'Kudos Wood' wood effect vinyl strip flooring ref: 1903 by Polyflor.

Page 8 and 10

Joy Large Alcove Pivot & Large Alcove Slider

Shower area tiles - 25 x 25mm matt white mosaic tile ref: B140 by Ceramique Internationale.

Wall to side of shower with shelves and bath panel - Oak effect laminate, ref: 2510 by Formica.

Floor - Kudos wood effect vinyl ref: 1902 by Polyflor.

Page 9

Joy Alcove Pivot

Shower area tiles - 25 x 25mm matt white mosaic tile ref: B140 by Ceramique Internationale.

Wall to rear of washbasin - timber effect laminate, ref: 5145 Rich Cherry by Formica.

Floor - Kudos wood effect vinyl ref: 1903 by Polyflor.

Page 11

Joy Quadrant

Wall tiles - 310 x 420mm 'Sintesis' matt white tiles by Ceramique Internationale.

Wall to rear of washbasin - timber effect laminate, ref: 5145 Rich Cherry by Formica.

Floor - Kudos wood effect vinyl ref: 1903 by Polyflor.

Page 14 - 17

Tribune Set

Wall tiles - 310 x 420mm 'Sintesis' matt white tiles and VID 5111 mosaic tiles by Ceramique Internationale.

Floor - Expona beech wood effect 1912 by Polyflor.

Page 20 & 21

Chiara Corner Pivot & Corner Bi-fold

Alto pedestal basin with Cone single lever basin mixer. Alto close coupled WC suite.

Wall tiles 200 x 200 matt white tiles with Rustica Mk-175 frost white border, from Ceramique Internationale.

Floor - Expona beech wood effect 1912 by Polyflor.

Page 22

Chiara Corner Entry Slider

Studio pedestal basin with Ceramix Alto mixer.

Studio close coupled WC suite.

Wall tiles as page 14.

Floor - Expona dark wood effect 6118 by Polyflor.

Chiara Alcove pivot

Studio close coupled WC suite.

Wall tiles as page 17.

Floor - Expona dark wood effect 6118 by Polyflor.

Page 23

Chiara Alcove Bi-fold

Studio pedestal basin with Cone single lever basin mixer.

Wall tiles - behind shower 200 x 200 matt white.

On wall Tivoli light crema mosaic effect, both by Ceramique Internationale.

Floor - Limestone effect 7173 by Polyflor.

Page 24

Chiara Large Alcove Pivot

Studio pedestal basin with Cone single lever basin mixer. Studio close coupled WC suite.

Wall tiles as page 17.

Floor - Expona dark wood effect 6118 by Polyflor.

Page 25

Chiara Large Alcove Bi-fold

Alto pedestal basin with with Ceramix Alto mixer.

Wall tiles as page 17.

Floor - Expona beech wood effect 1912 by Polyflor.

Chiara Large Alcove Slider

Studio pedestal basin with Cone single lever basin mixer. Studio close coupled WC suite.

Wall tiles as page 17.

Floor - Limestone effect 7173 by Polyflor.

Page 26

Chiara Quadrant

Alto pedestal basin with with Ceramix Alto mixer.

Wall tiles 250 x 330 Surface white tiles by Ceramique Internationale.

Floor - Limestone effect 7173 by Polyflor.

Page 27

Chiara Pentagon Pivot

Studio pedestal basin with Cone single lever basin mixer. Studio close coupled WC suite.

Wall tiles 250 x 330 Surface white tiles by Ceramique Internationale.

Floor - Limestone effect 7173 by Polyflor.

Chiara Pentagon Bi-fold

Alto pedestal basin with with Ceramix Alto mixer.

Wall tiles as above.

Floor - Sandstone effect 7162 by Polyflor.

Page 32

Modular Framed Corner

Create square pedestal basin with Silver monoblock single lever basin mixer, Create Square close coupled wc suite, Cone 50cm glass shelf, Cone robe hook.

Wall tiles - Sintisis matt white wall tiles with Quartzite mosaic border by Ceramique Internationale.

Flooring - Quartzite by Ceramique Internationale.

Page 33

Modular Framed Corner Entry

Create Drift 56cm pedestal basin with Ceramix Alto single lever basin mixer, Cone 50cm glass shelf.

Wall tiles - as page 26.

Flooring - Polyflor Oak Effect

Modular Framed 1200 Corner

White Round 50cm basin with pedestal and Silver monoblock single lever basin mixer, White bath.

Wall tiles and flooring - as page 26

Page 34

Modular Framed Large Alcove

Create Drift 56cm pedestal basin with Cone single lever basin mixer, Cone robe hooks and Cone soap dispenser.

Wall tiles as page 29

Flooring - Tuscolano tiles by Ceramique Internationale

Page 35

Modular Framed Alcove

Alto 60cm pedestal basin with Ceramix Alto mixer, Cone 50cm glass shelf.

Wall tiles - Coimbra Olivia wall tiles with Travertine mosaic tiles by Ceramique Internationale.

Flooring - Plank Timber Effect by Polyflor

Modular Framed Quadrant

White Round 50cm basin with pedestal and

Silver monoblock single lever basin mixer,

Cone 50cm glass shelf, Cone towel ring.

Wall tiles - as page 26.

Floor - Polyflor Oak Effect vinyl strips.

Page 38

Modular Frameless Corner &

Modular Frameless Corner Entry

Alto 60cm pedestal basin with Ceramix Alto mixer, Alto close coupled wc suite.

Flooring - White Slate vinyl flooring by L F Direct.

Page 39

Modular Frameless 1200 Corner

White Round 50cm basin with Silver 3 hole deck mounted basin mixer

Floor - Polyflor Expona beech wood effect 1912.

Page 40

Modular Frameless Alcove

Purity pedestal basin with Ceramix Alto mixer,

Purity close coupled wc suite.

Floor - Nera Contract Dark Wood Timber Effect vinyl flooring by Gerflor.

Modular Frameless Large Alcove

Floor - White Slate vinyl flooring by L F Direct.

Page 41

Modular Frameless Quadrant

Alto 60cm pedestal basin. Alto close coupled WC suite.

Floor - Polyflor Expona beech wood effect 1912.

Modular Frameless Pentagon

Kyomi 59cm pedestal basin with Academy basin and bath fittings.

Flooring - Polyflor Kudos Stone Travertine Effect vinyl.

Page 44 & 46

Connect 750, 900 & Shower Guard

200 x 200 Matt white tiles with 15 x 15 Polished Botticino boarding and 50 x 50 Ganges CLR inlay tiles by Ceramique Internationale.

Floor - Polyflor Oak Effect vinyl strips.

Page 47

Connect 5 fold & Rialto

200 x 200 Matt white tiles with 50 x 50 inlay tiles Tigris Clear, Fraser Clear, Chico clear by Ceramique Internationale.

Contact numbers and acknowledgments

Ceramique Internationale - 0113 231 0218

Polyflor - 0161 767 1122

Gerflor - 01926 401500

L F Direct - 01482 824700

Cone range of accessories by Ideal Standard

All bathroom and
shower products
featured in this brochure
are produced by
Ideal Standard (UK) Ltd.

For more information
please see our
International Collection,
Trevi and Live the
Ideal brochures.

To obtain copies please
telephone 0800 614191

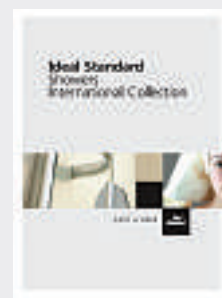

B O D Y & M I N D

*Ideal
Standard*

The Bathroom Works
National Avenue
Kingston Upon Hull
HU5 4HS
T 01482 346461
F 01482 445886